

画地確定図

縮尺 1 : 500

街区番号 1

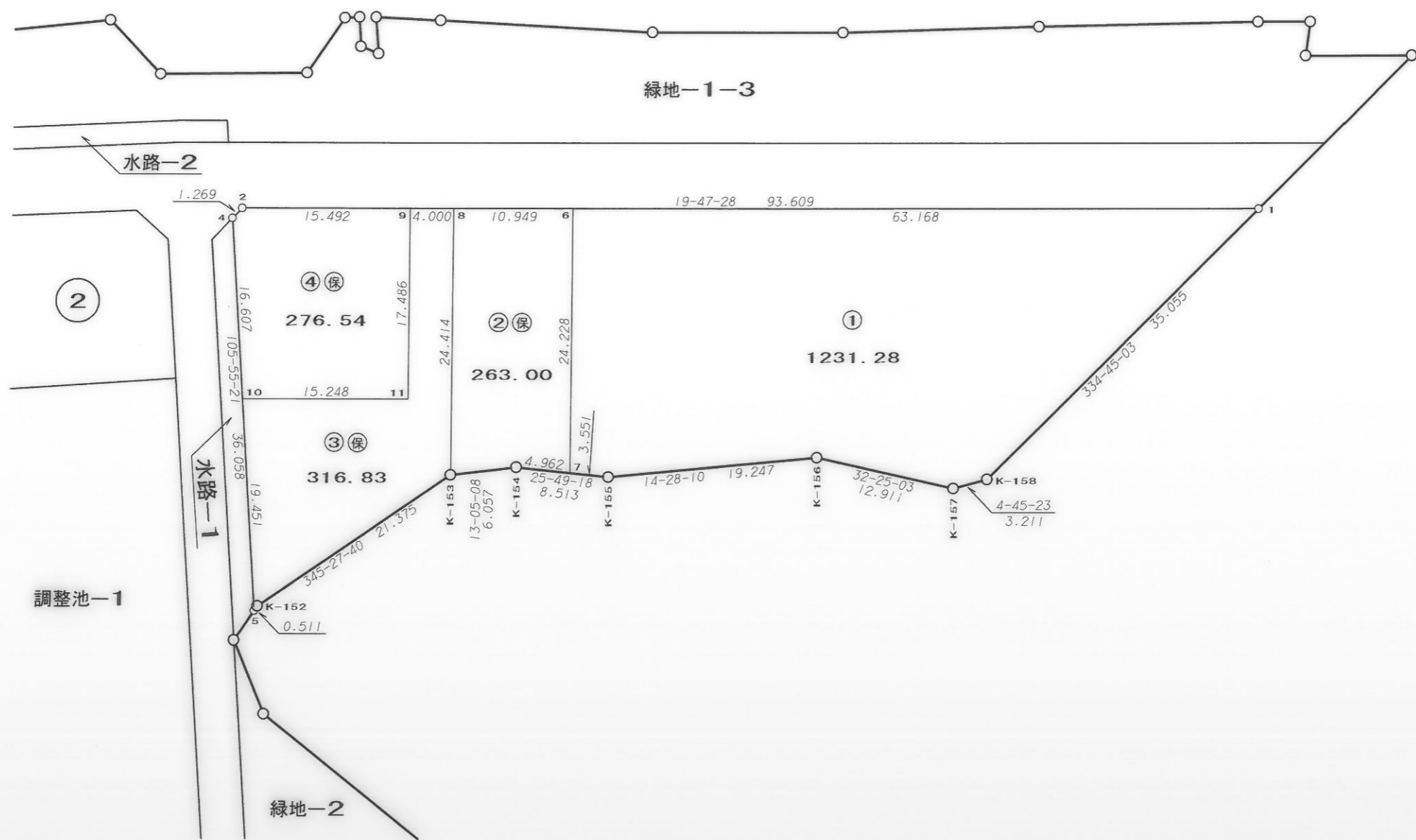
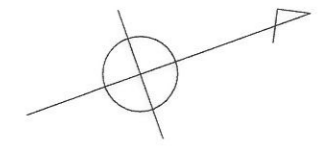

画地確定図

縮尺 1:500

街区番号 2

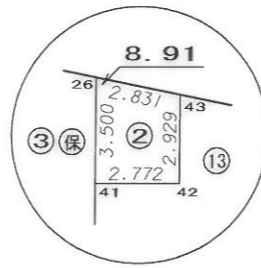

S=1:250

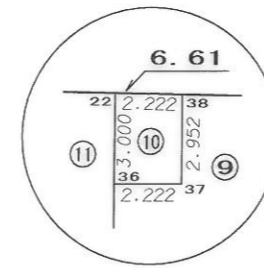

S=1:250

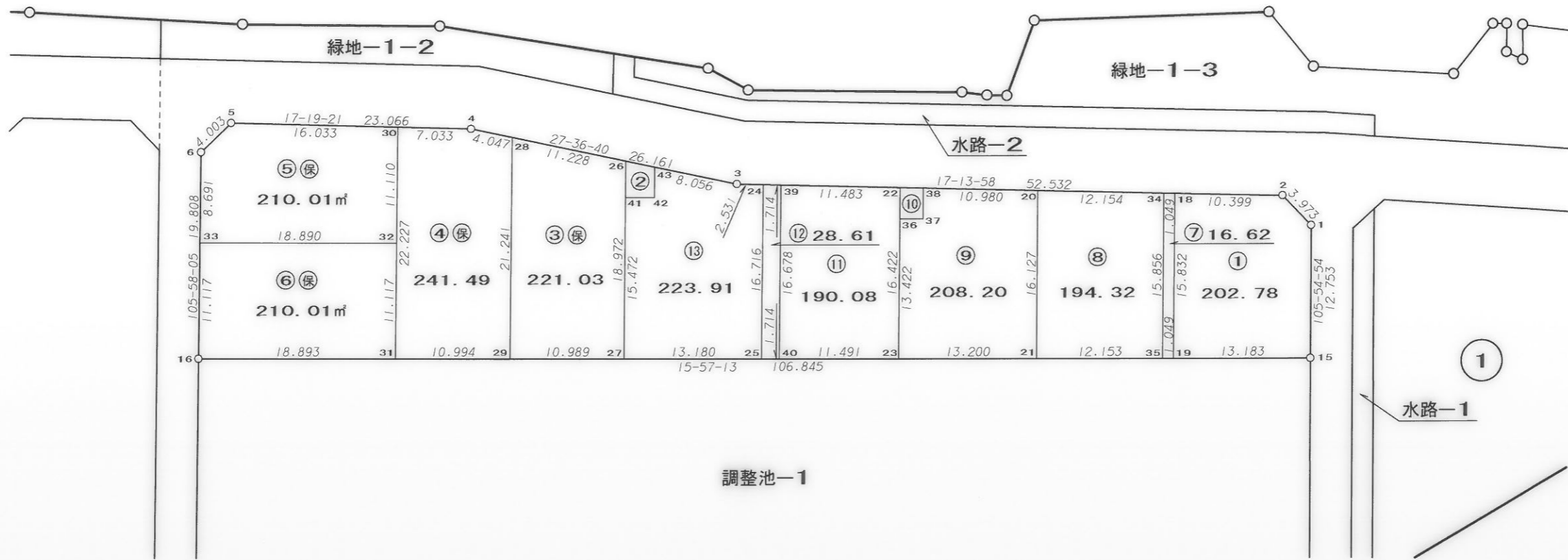
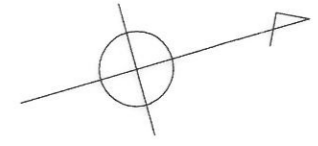

画地確定図

縮尺 1 : 500

街区番号

3

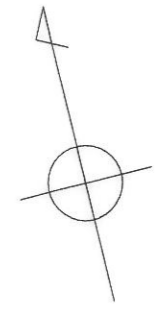

画地確定図

縮尺 1 : 500

街区番号

4

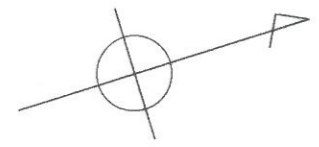

緑地-1-1

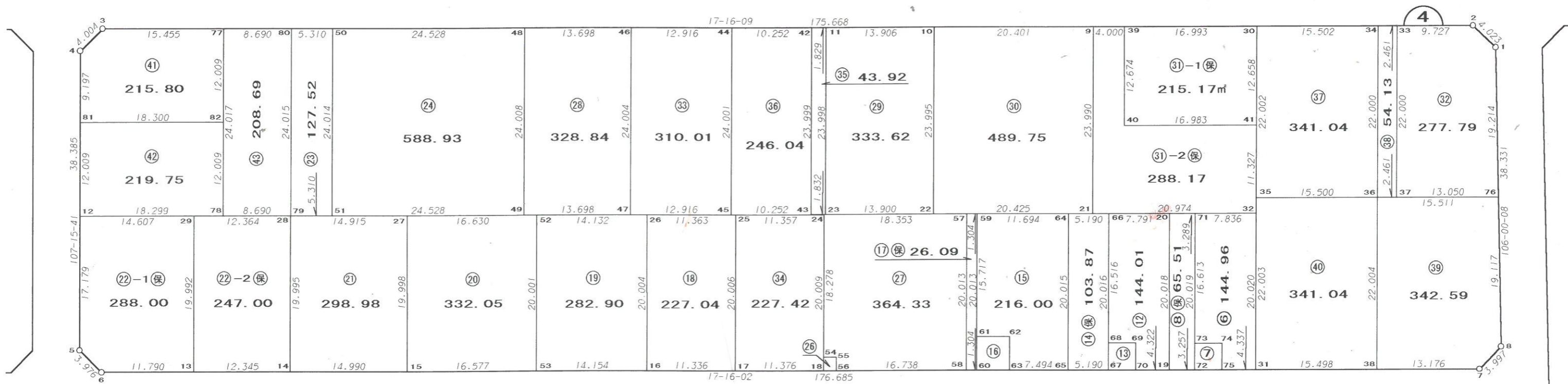

9

8

7

6

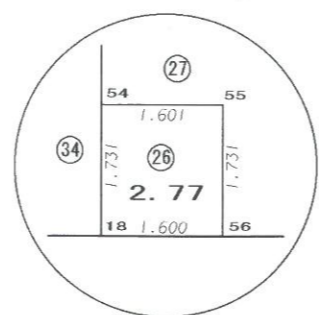

S=1 : 100

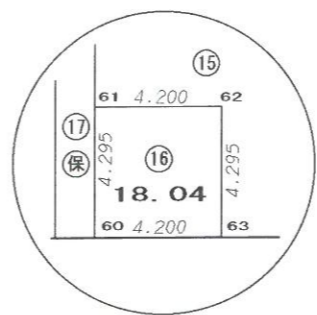

S=1 : 250

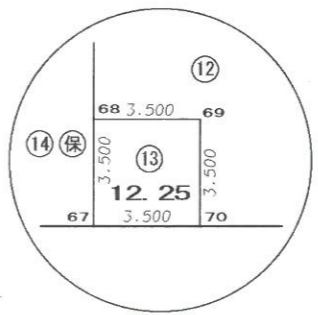

S=1 : 250

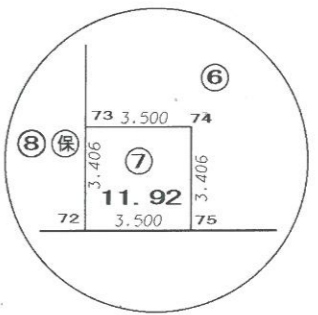

S=1 : 250

画地確定図

縮尺 1 : 500

街区番号 5

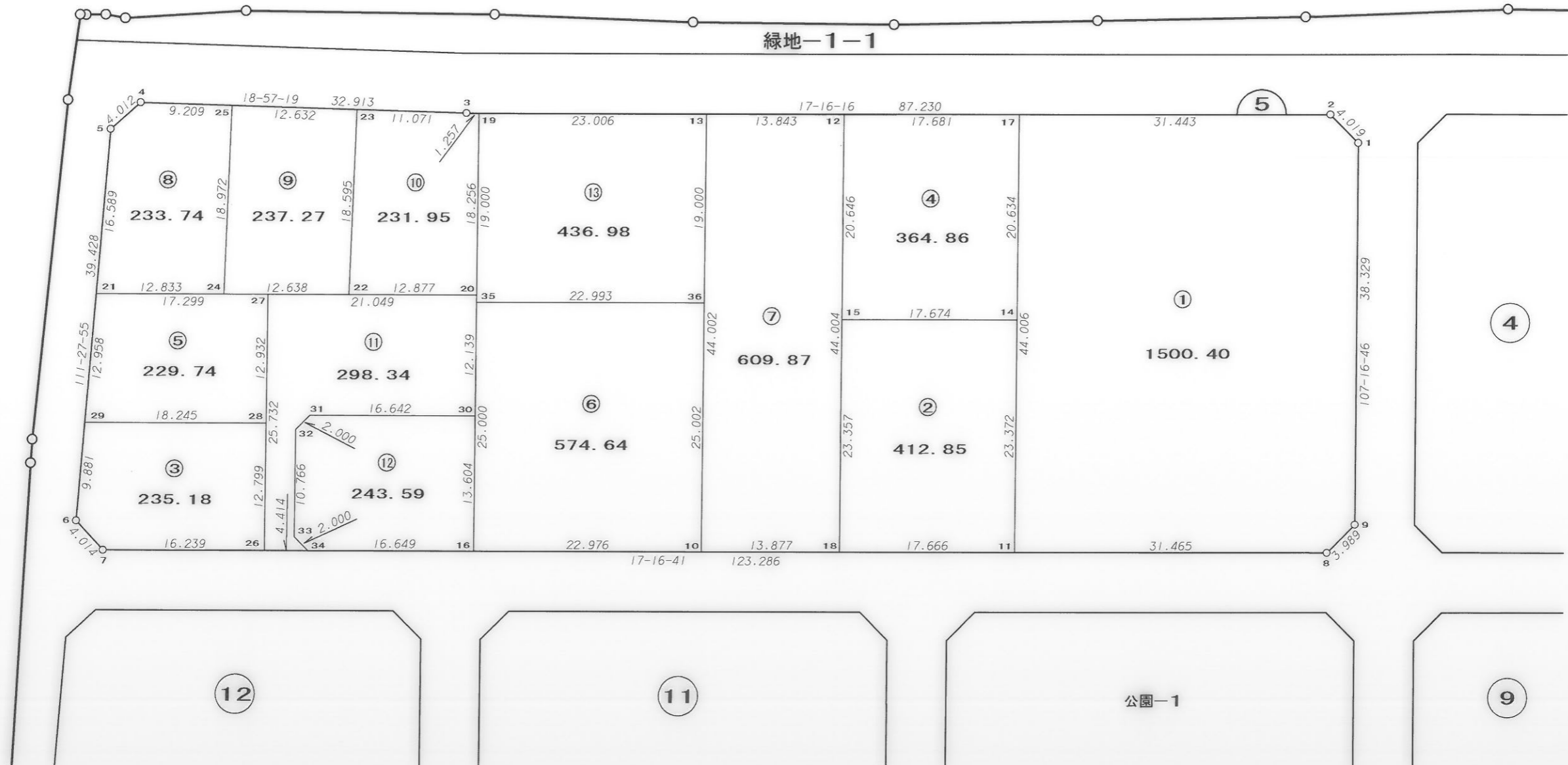
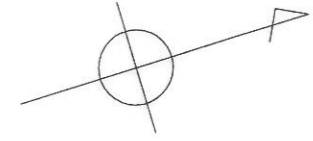

画地確定図

縮尺 1 : 500

街区番号 6

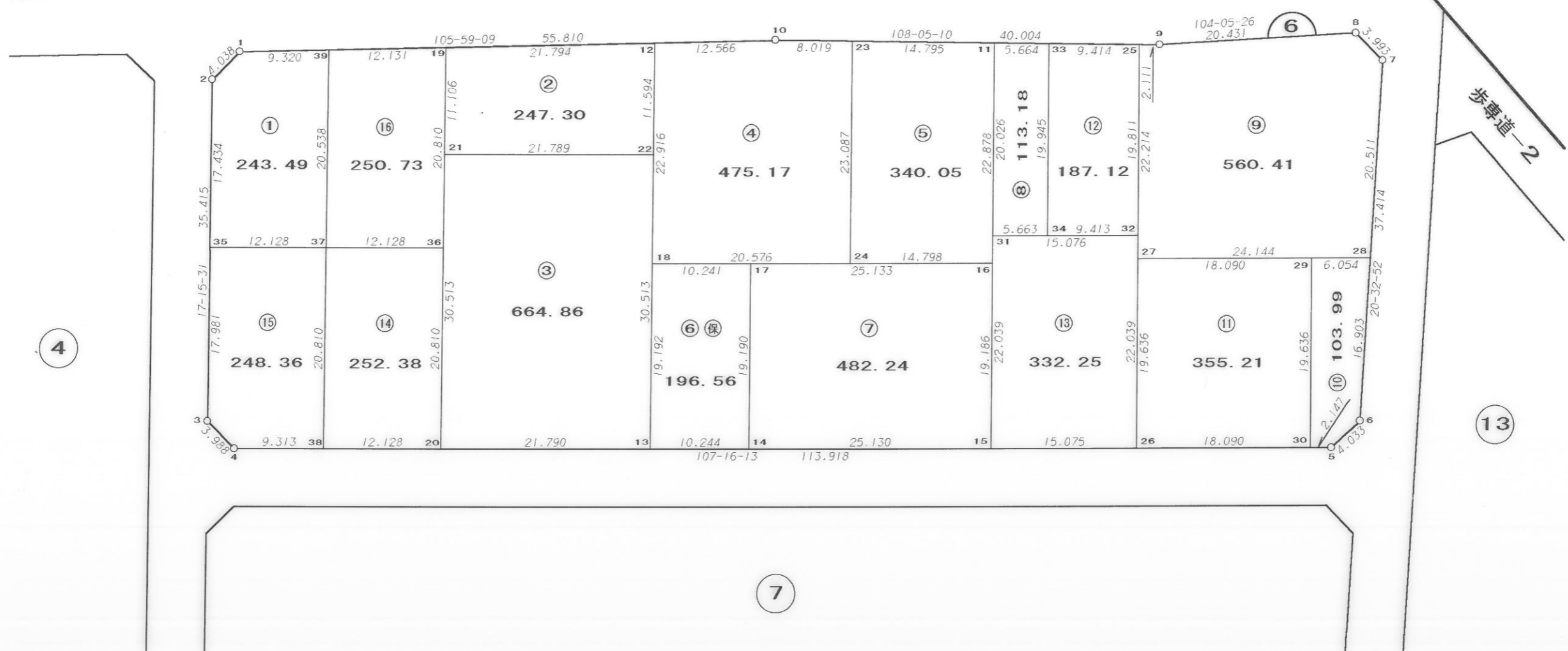
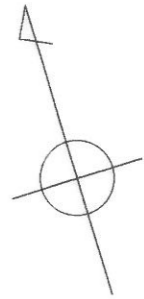

4

7

13

歩道-2

画地確定図

縮尺 1 : 500

街区番号

7

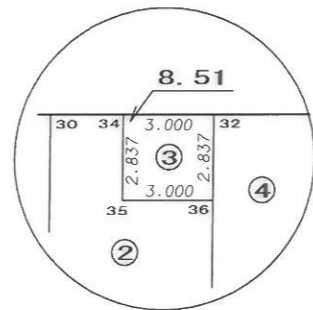

S=1 : 250

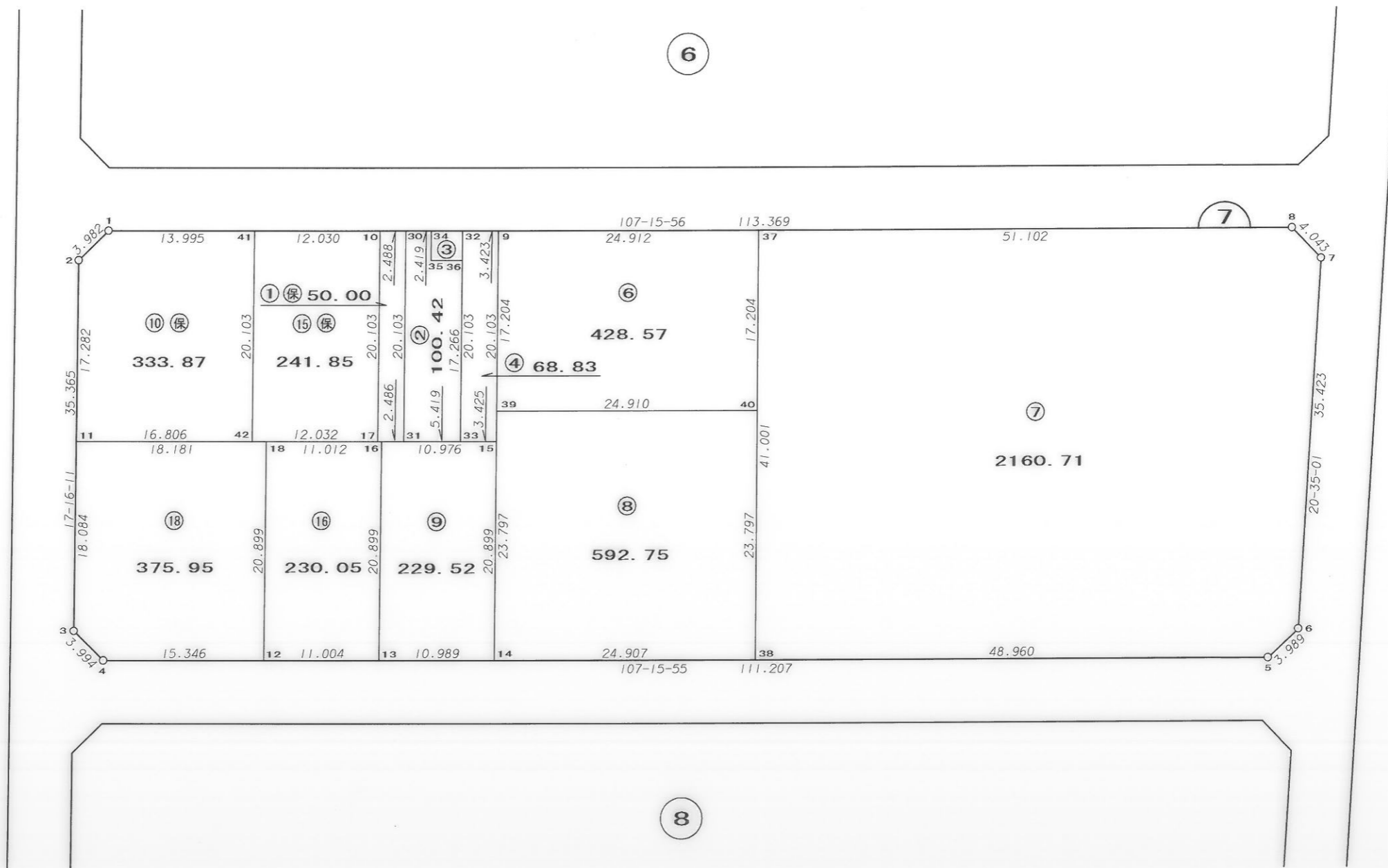
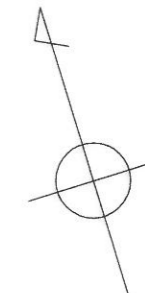

画地確定図

縮尺 1 : 500

街区番号 8

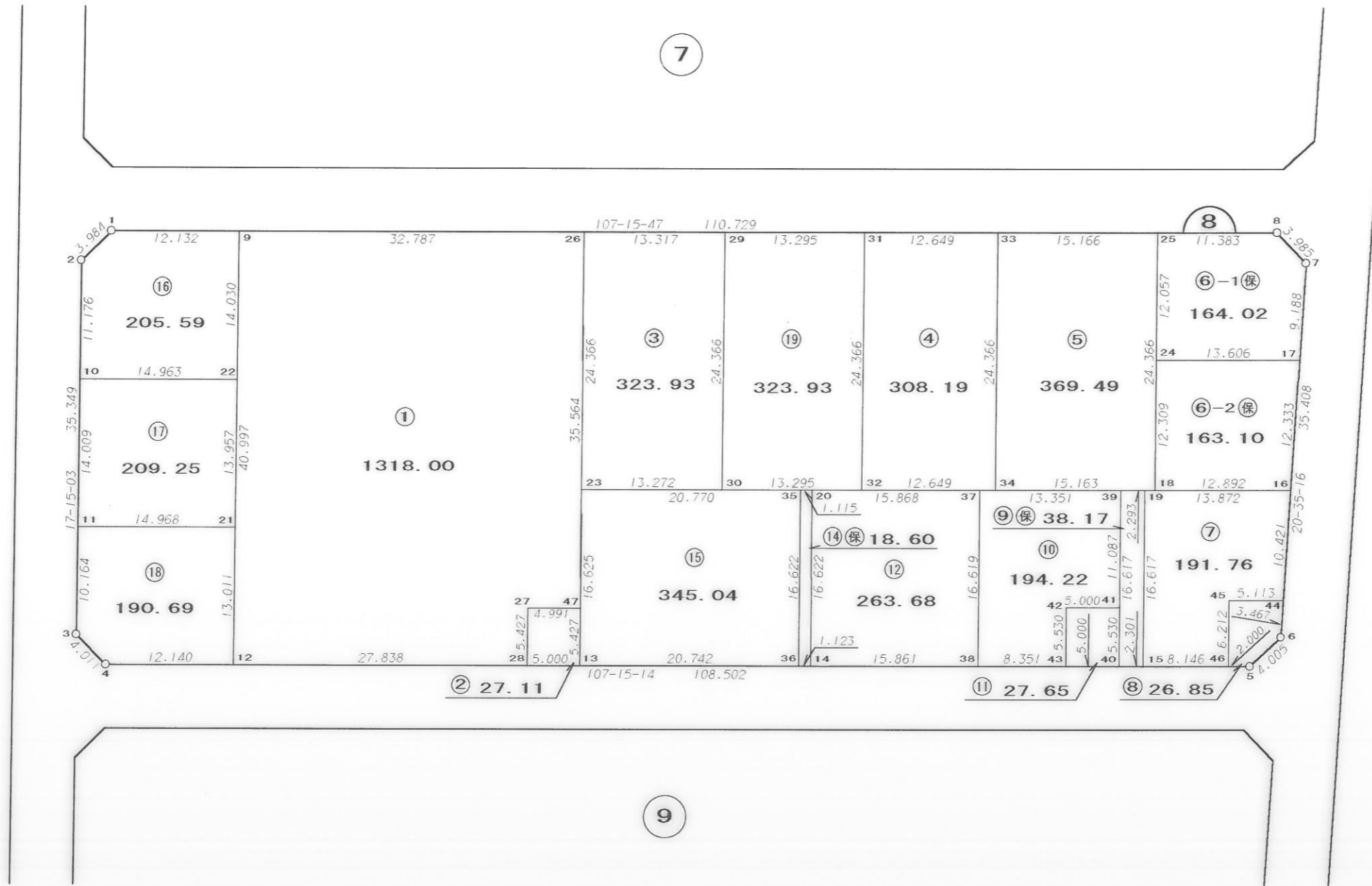
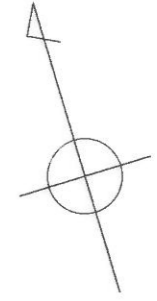

4

7

13

9

画地確定図

縮尺 1 : 500

街区番号 9

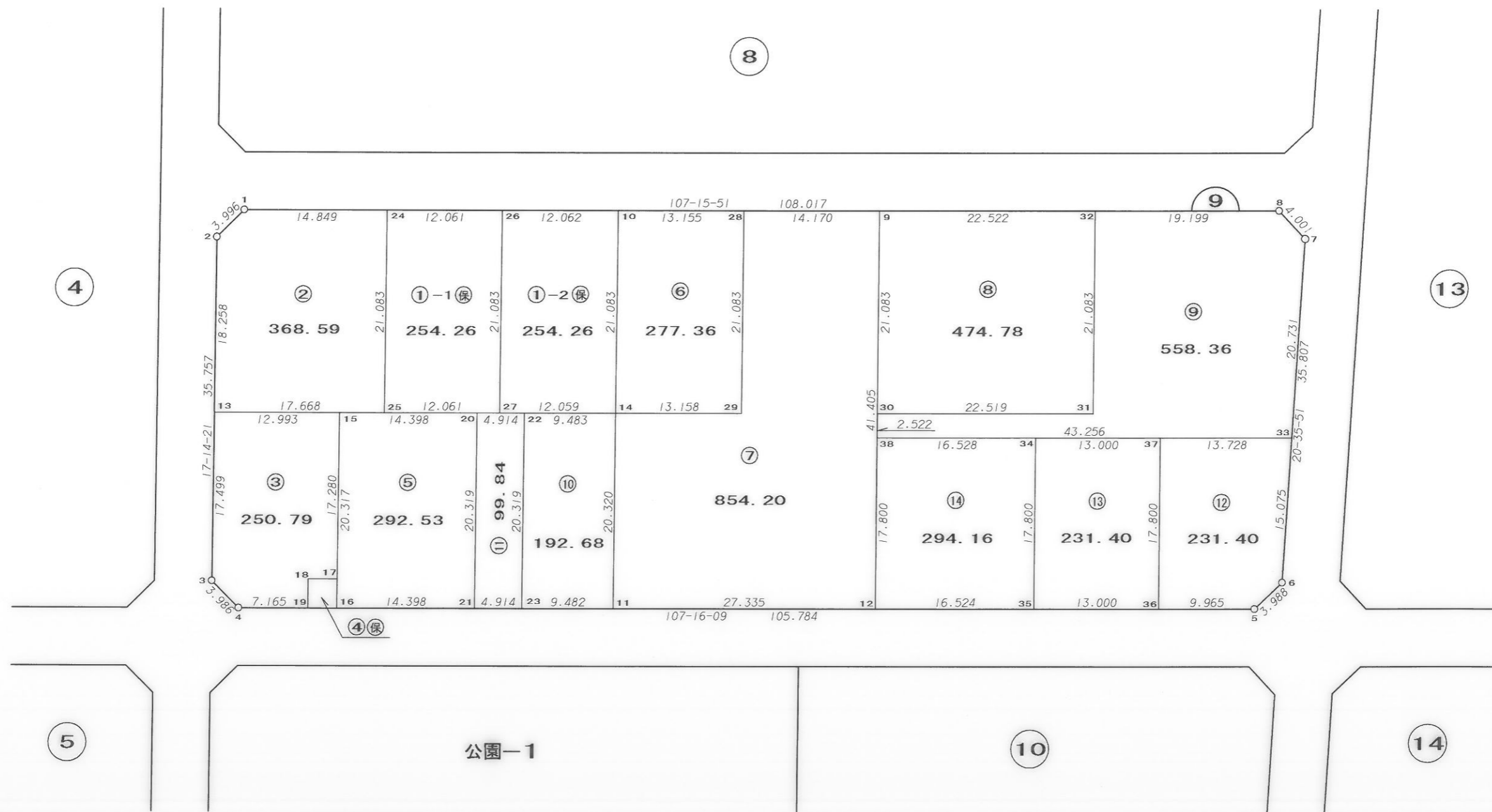
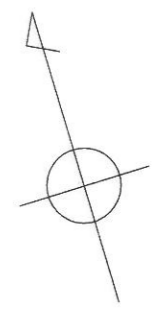

公園一1

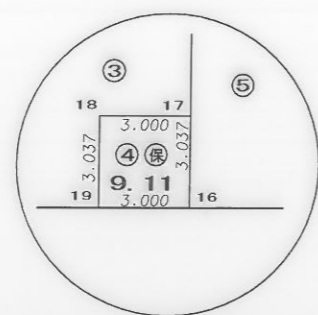

S=1 : 250

画地確定図

縮尺 1 : 500

街区番号 10



画地確定図

縮尺 1 : 500

街区番号 11

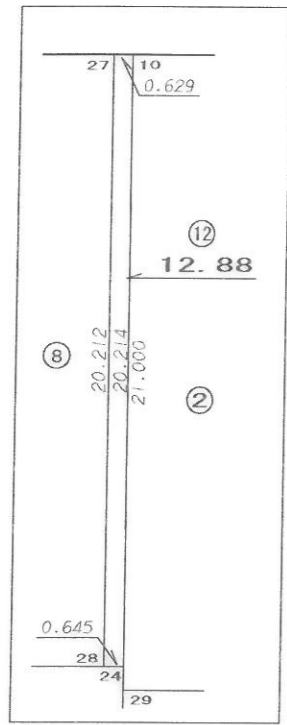

S=1 : 250

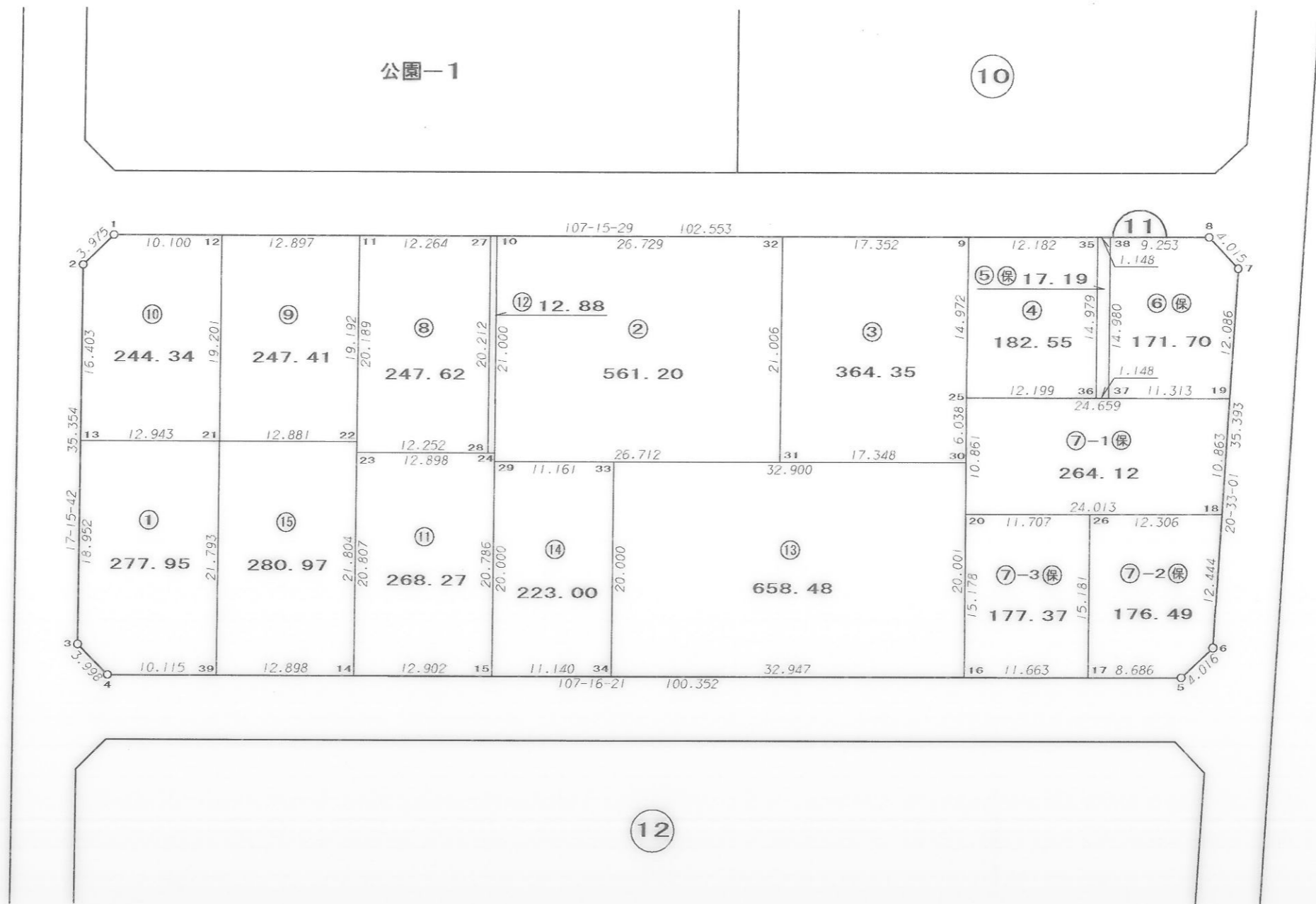
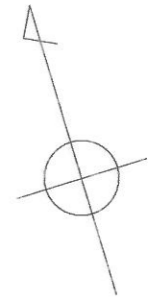

公園-1

5

14

12

10

11

画地確定図

縮尺 1 : 500

街区番号 12

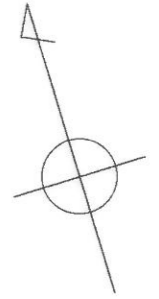

画地确定图

縮尺 1 : 500

街区番号 13

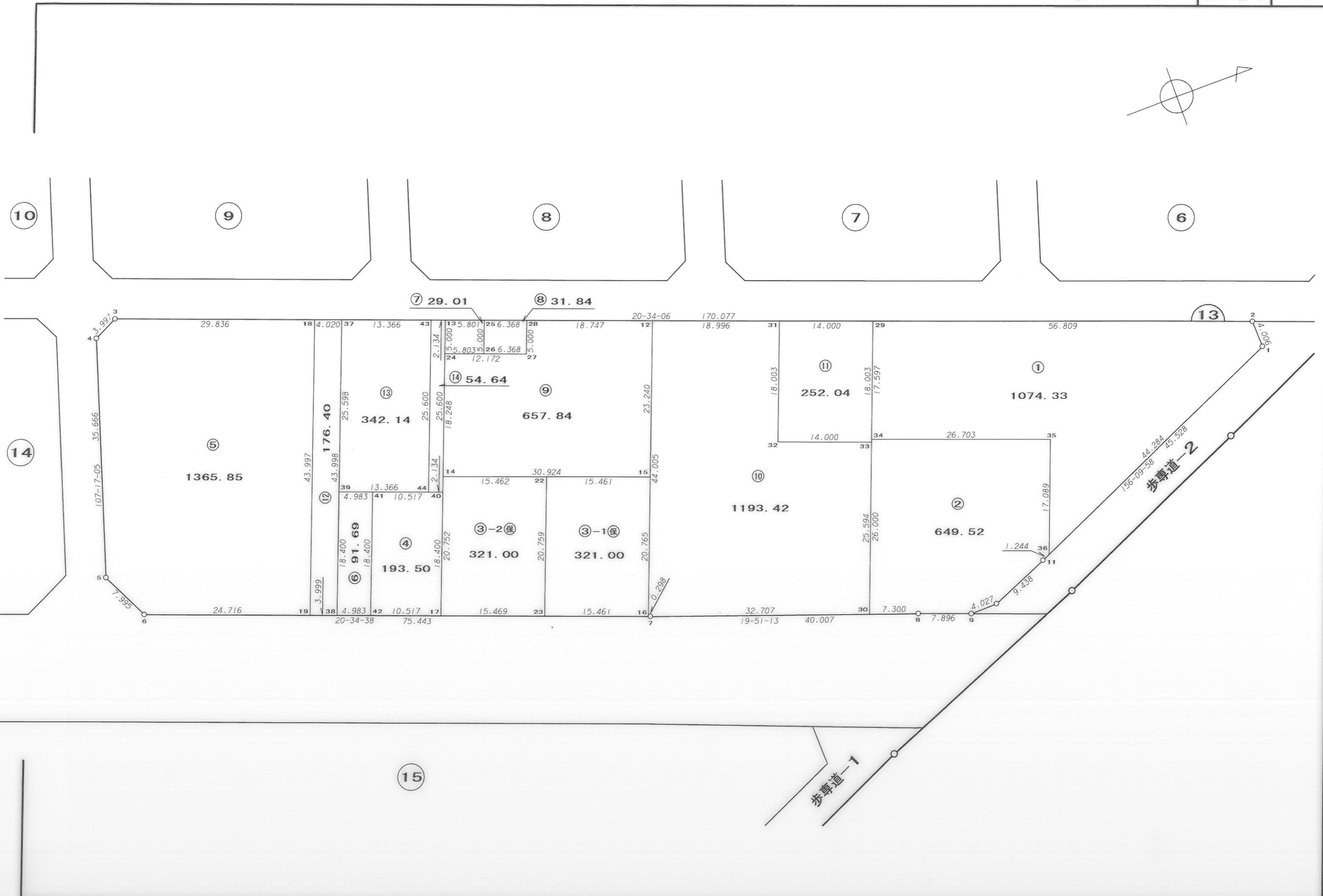
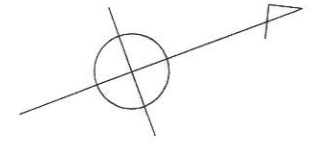

画地确定图

縮尺 1 : 500

街区番号

14

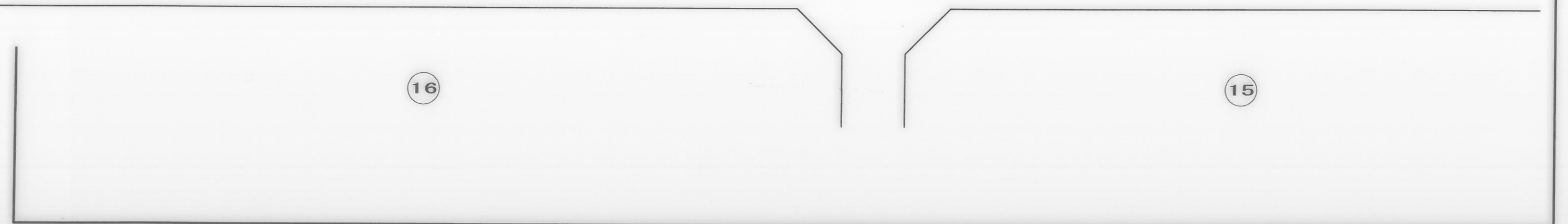
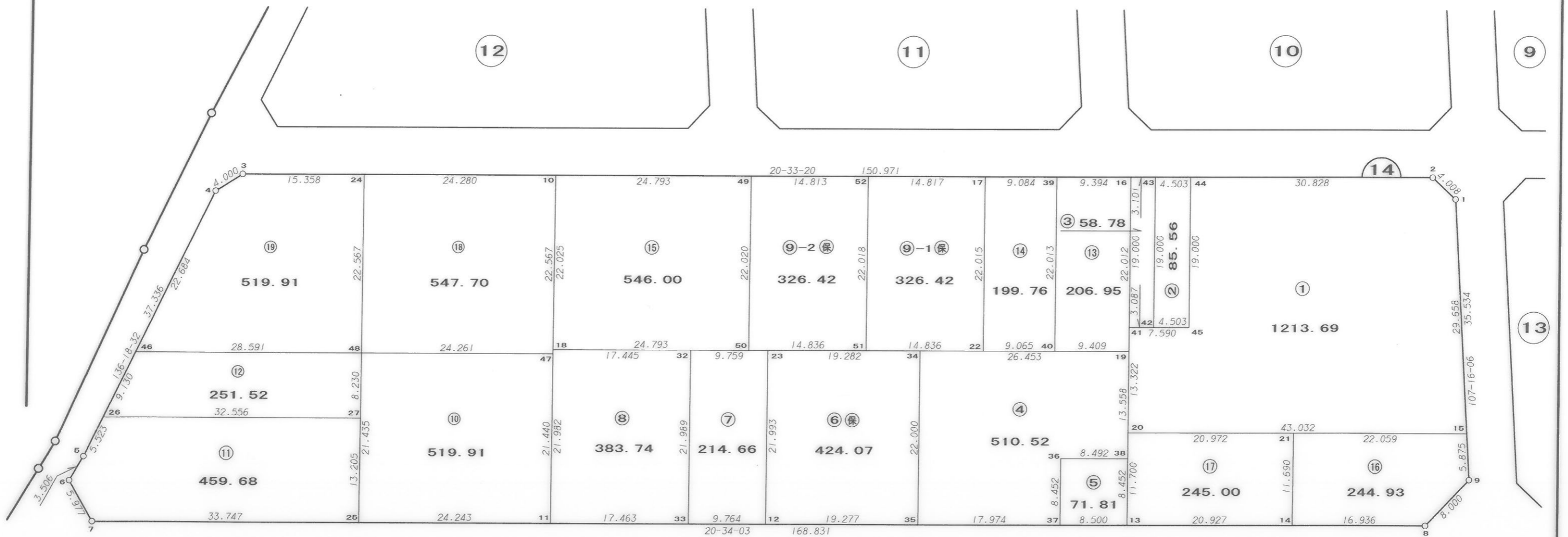
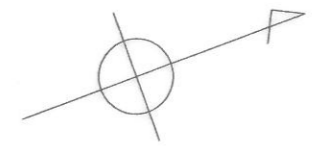

画地確定図

縮尺 1:500

街区番号 調整池-1

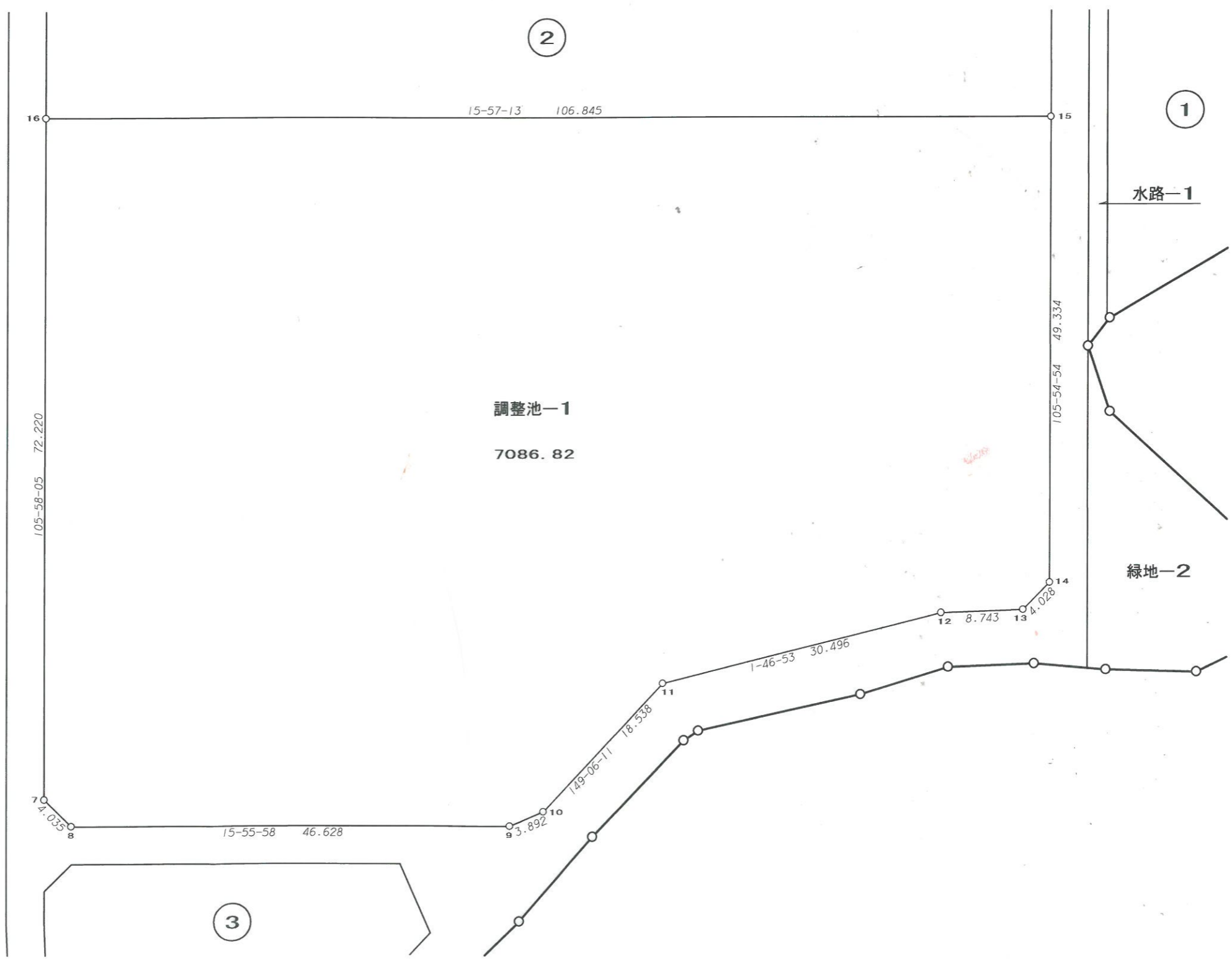
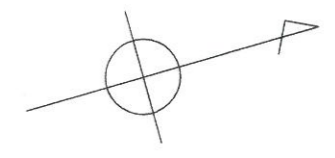

画地確定図

縮尺 1 : 500

街区番号 公園-1

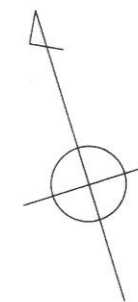

4

9

5

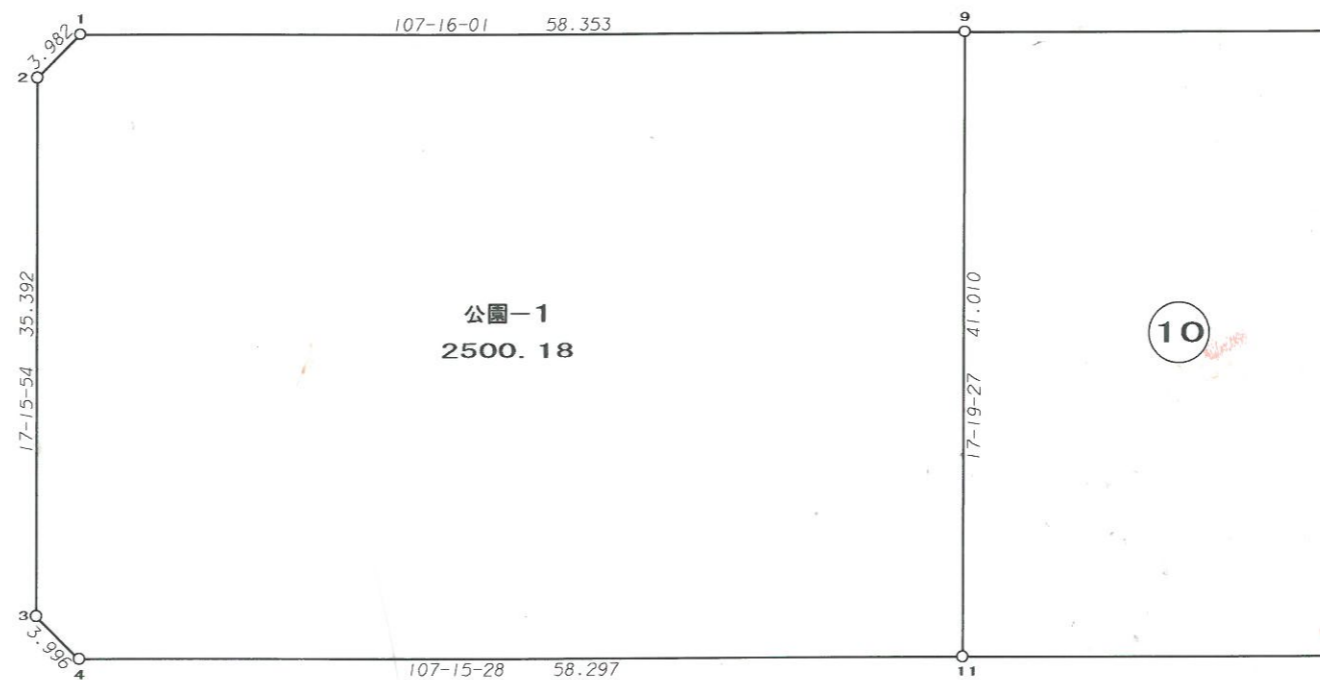

公園-1
2500.18

10

11